

KO NGĀ WĀHANGA ME NGĀ RAUEMI

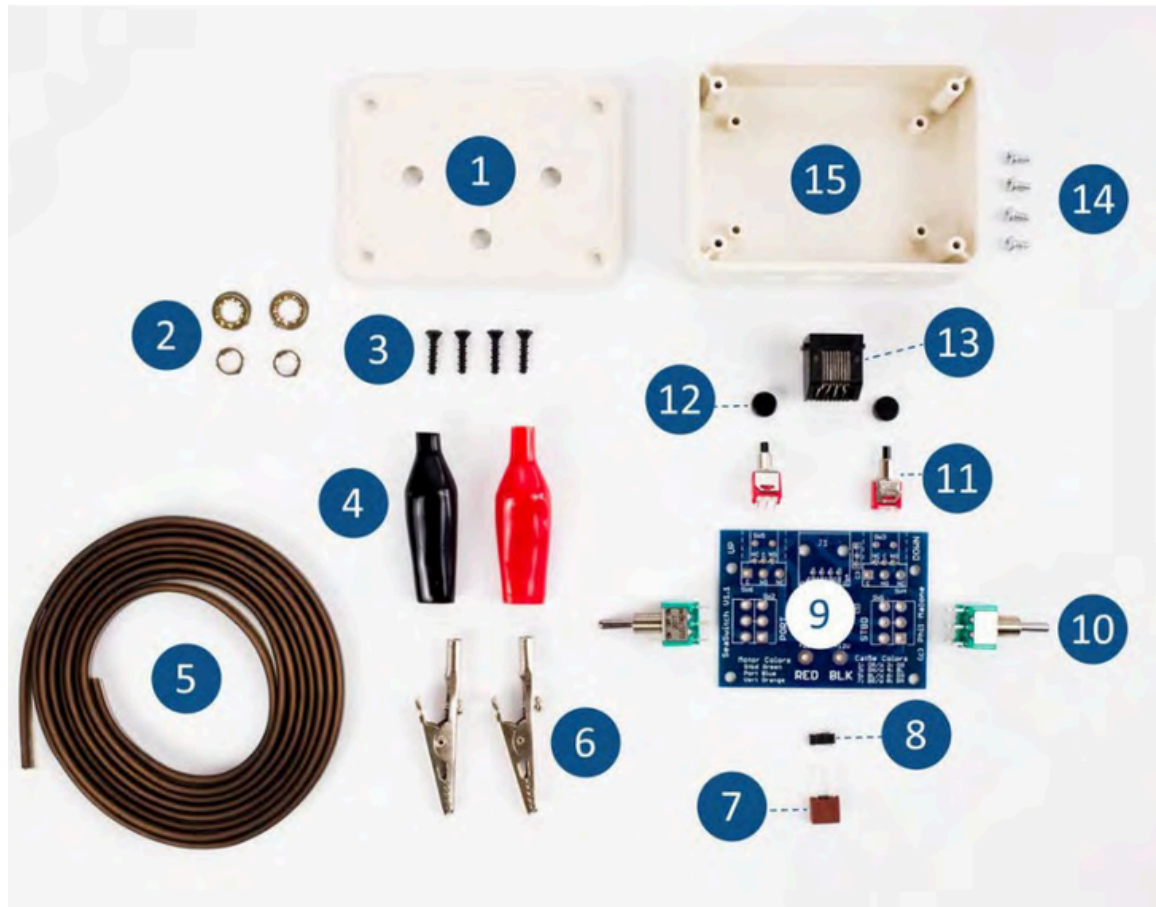

1. Control Box Lid
2. Toggle Switch Nuts and Washers
3. 4x Black Screws
4. 2x Alligator Clip Insulators
5. 18 AWG Wire
6. 2x Alligator Clips
7. Fuse
8. Fuse Holder
9. Printed Circuit Board (PCB)
10. 2x Toggle Switches
11. 2x Pushbutton Switches
12. 2x Pushbutton Switch Caps
13. RJ45 Connector Jack
14. 4x Silver Screws
15. Control Box Enclosure



KIA MATAARA

Ko te hāpiapia whakapiri he mea matepa i ngā ringaringa me ngā whatu. Ko te tikanga ia me mau mōhiti haumaruru me ngā karapu i nga wā katoa i a koe whakamahi i ngā hāpiapia. Horoia ngā ringaringa i ngā wā katoa i a koe whakamahi i ēnei mātiu.

Kei te pukapuka tohutohu ngā whakaahua.

Nā www.seaperch.org i waihanga.

Nā Tōnui Collab rāua ko Tapuwae Roa i whakamāoritia.

KO NGĀ WĀHANGA ME NGĀ RAUEMI



1. Wax Bowl Ring
2. 50' Network Cable (tether cable)
3. Electrical Tape
4. Poly Butyl Tape
5. 3x Die Cut Vinyl Tape Set
6. 3x 4-40 Self-locking Hex Nuts
7. 3x 4-40 Tee Nuts
8. 3x 4-40 Threaded Propeller Shaft Couplers
9. 3x Propellers
10. 3x 12-Volt DC Motors
11. 3x Thruster Housings and Caps
(35 mm Film Canisters with Caps)

Kei te pukapuka tohutohu ngā whakaahua.

Nā www.seaperch.org i waihanga.

Nā Tōnui Collab rāua ko Tapuwae Roa i whakamāoritia.

ROV

Tirohia te wāhanga whakamahinga taputapu, ngā pukenga, me ngā haumarutanga, kia mōhio ai me pēhea ngā haumarutanga ki te wiri me ngā nihowiri.

- Tautohu kia toru o ngā 4 inihi paipa roa.
- Ki te tāmāu to ia paipa ki te purimau o te tepu i a koe ine ai te paipa.
- Puritia te rure kia whakarara ki te paipa, Mākahia ngā tauwāhi o ngā kohao thruster mounting me tētahi raina tōtika ki te taha o te rure, hei putahitanga ki ngā wāhanga kohao kua mākahia
- Tāruatia mō ngā paipa e rua 4 inihi te roa.
- Whakakopa te paipa ki te purimau, kauhuritia ake kia kite ai i ngā wāhanga kua mākahia. Tangohia tētahi o ngā rapa whakapuru mai i te purimau.

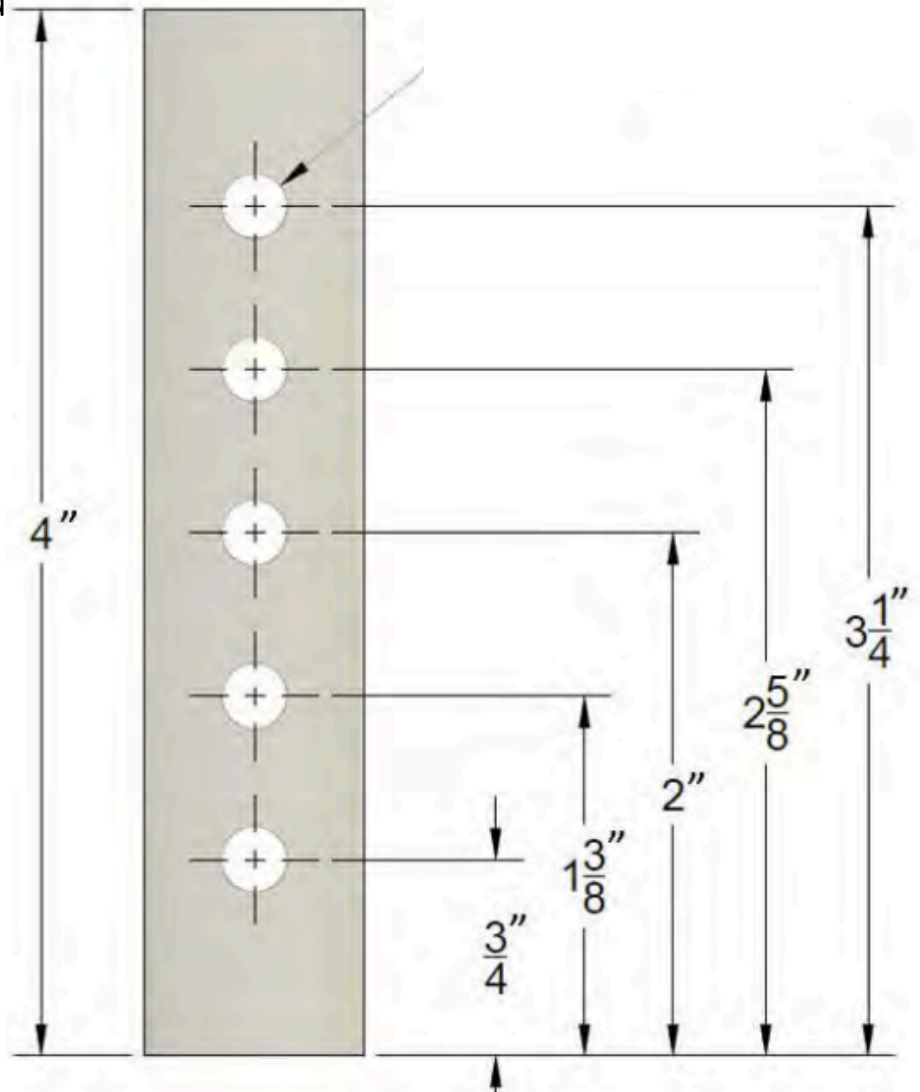

PAIPA

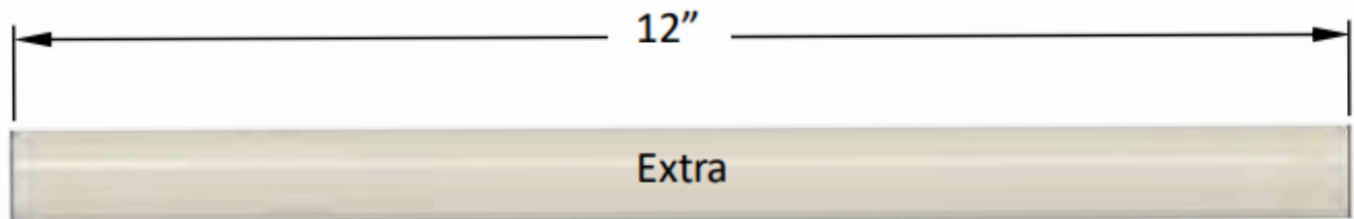
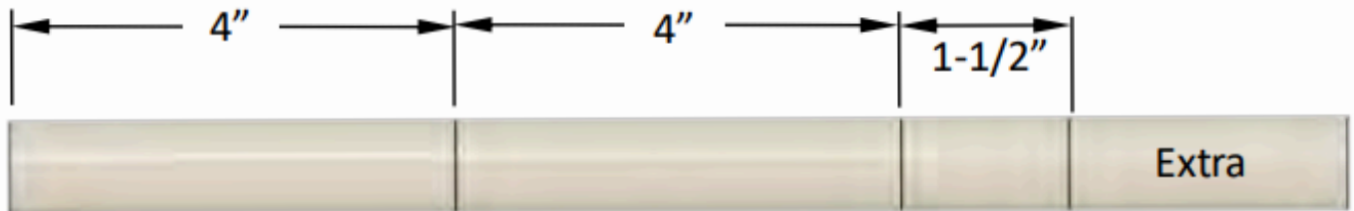
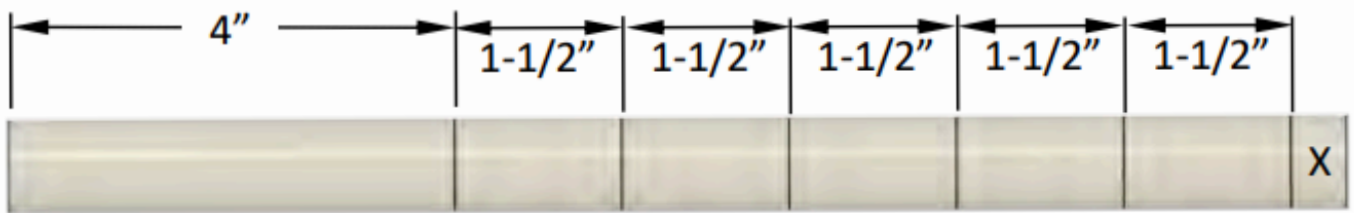
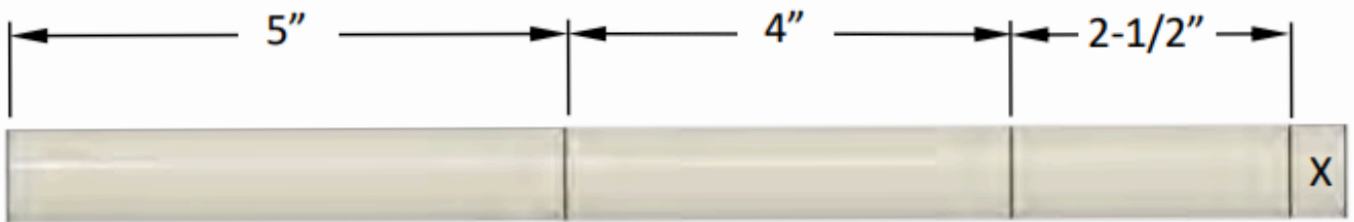
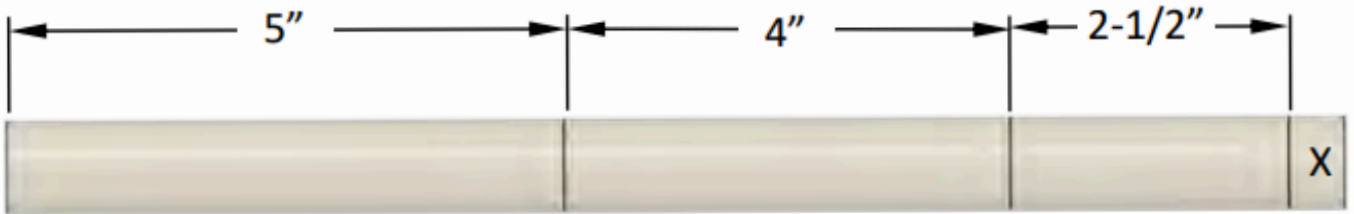

- Whakaurua ngā 5 inihi paipa ki ngā wāhanga purewa 2 inihi te roa i mua i te tūhono o ngā 'elbows'. Whakatauria ngā paipa 'thruster' mounting me nga kohaohao rite ki te whakaahua.

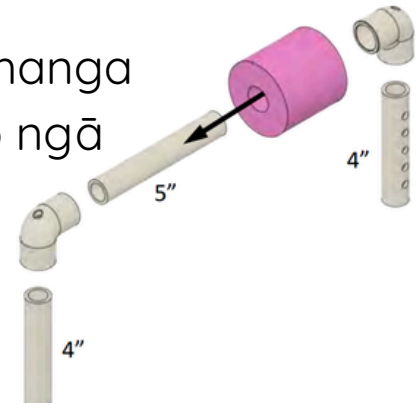

- Hangaia te taura ki te wāhanga heke iho ki te taha matau (whakaahua 1) me te wāhanga heke io ki te taha mauī (whakaahua 2). He rite ēnei wāhanga, engari he rerekē te ahunga o runga, o raro hoki o ngā elbows.

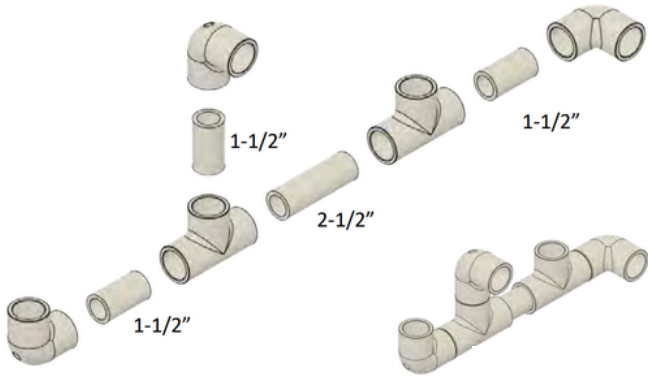

whakaahua 1

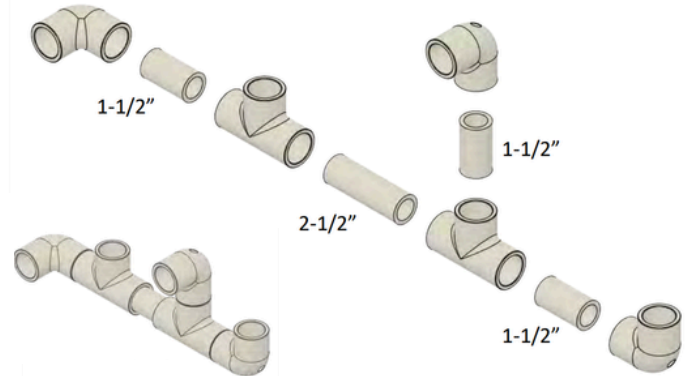

whakaahua 2

- Hangaia ngā taipari, o runga, ā o raro hoki - te taha matau me te taha mauī (whakaahua 3, 4, 5)

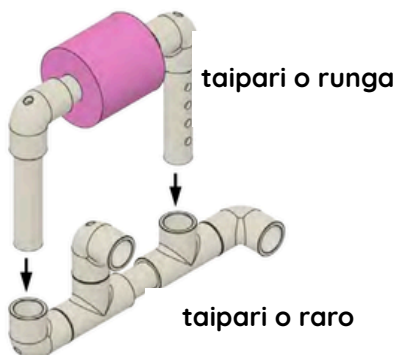

whakaahua 3

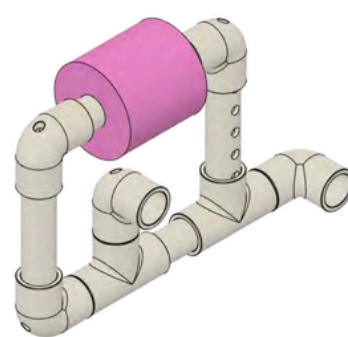

whakaahua 4

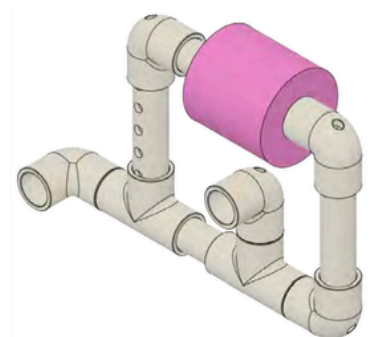

whakaahua 5

- Tuhono ngā taipari e rua me te paipa 4 inihi te roa ā kātahi hono atu tērā atu paipa 4 inihi te roa o te 'thruster mounting'.

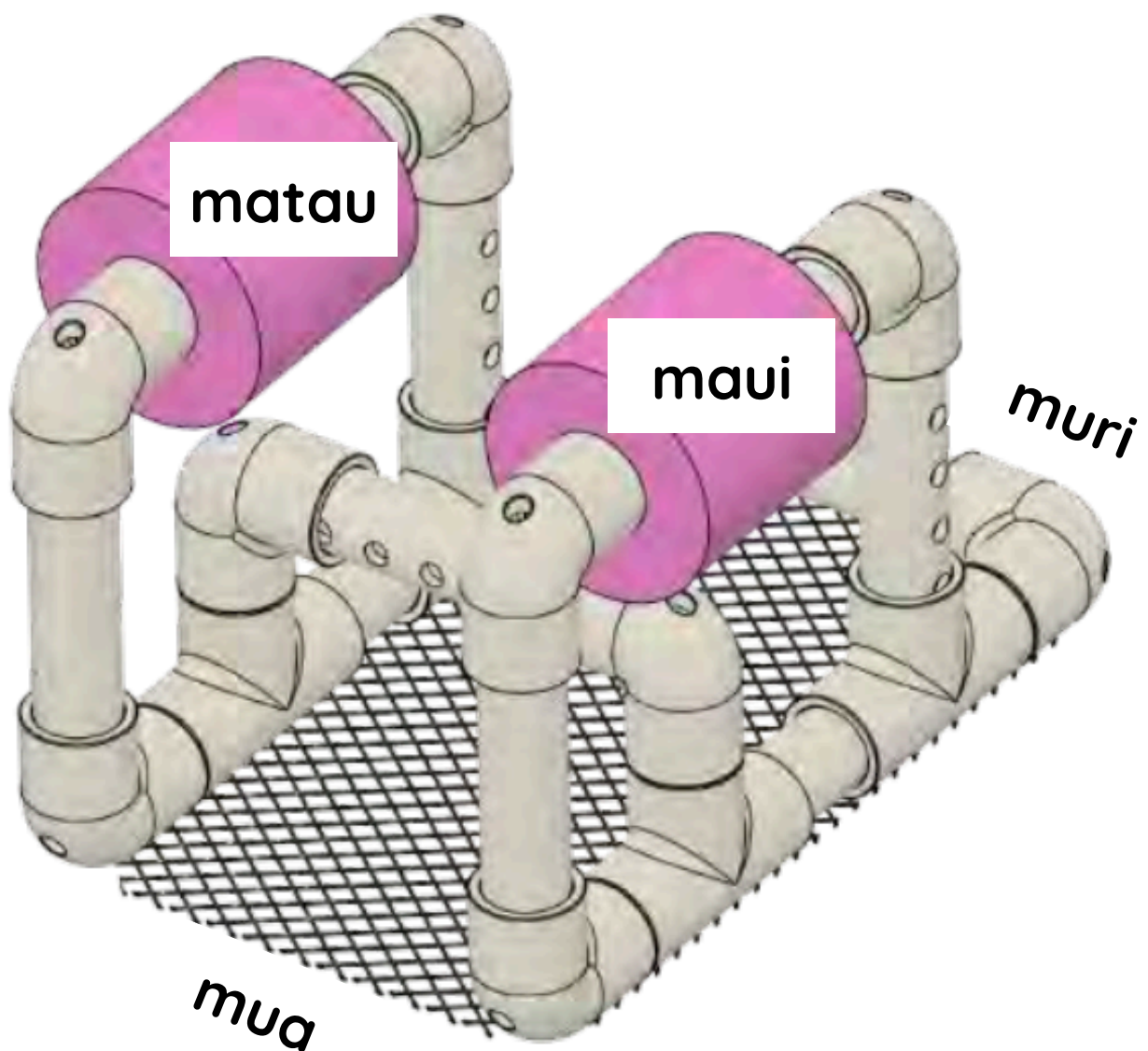
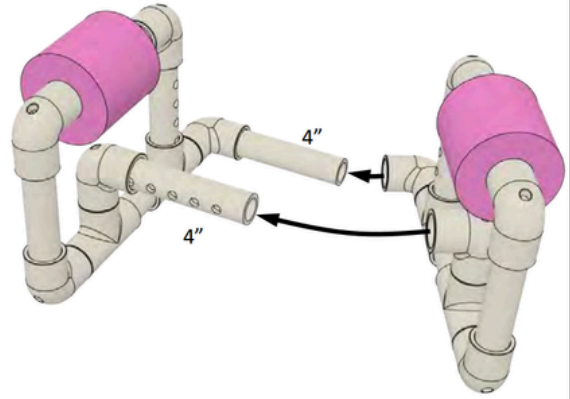

CANISTERS

5

1. Whakamahia te nihowiri iti, kia wiri ai he kohao ki waenganui o te 'canister', o runga, ā o raro hoki.
2. Tangohia ngā taupoki, tirohia ina he matara e arai ana i te kohao ki raro iho o te 'thruster housing'.

Kia mōhio ai koe me tango i nga matara, ka uaua te whakauru i tētahi 'motor shaft' a te wā e whakamātau ana i te hātepe pītongatonga.



3. Whakainehia me tētahi rure kia 15 inihi, mai te taura herehere (te taha kāore he ārai).
4. Mākahia me tetahi pene ki te taura.
5. Pēhi ngā herehere ki waenganui i ou matimati kia papatahi ngā herehere katoa.
6. Waiho te taura ki te tupāpā mahi. ā pupuri te taura rāno kia haumaru koe ki te paheke te 'diagonal cutting pliers'.
7. Whakamahia ngā 'diagonal cutting pliers' ā hōripi kia tūwhera ai te papanga o te taura, kia hura kia 1 inihi ngā waea kara.



8. Ka mau ngā waea kara ki tetahi ringa, ā ka kukume ngā waea kia puta mai i te papanga ki te māka 15 inihi.

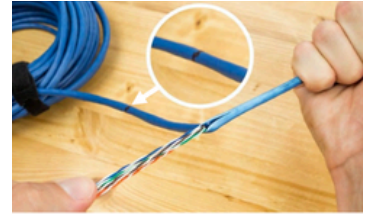

9. Whakamahia he kutikuti, he 'diagonal cutting pliers' rānei kia poroa te papanga anake, kia āta haere koe, kia kauaka e tapa, e poro rānei i ngā waea kara.



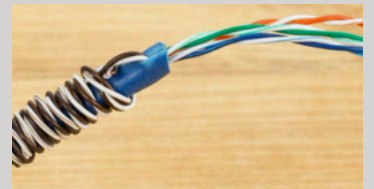

TĀKOHA - Ka tauwehe noa i te papanga KAUKA ko ngā waea!

- Ko te tikanga ia e maea ana kia whā anake ngā waea kara.
Karaka (he tūmaro, he tarapu mā)
Kākāriki (he tūmārō, he tarapu mā)
Kahurangi (he tūmārō, he tarapu mā)
Parauri (he tūmārō, he tarapu mā)
- Ka waiho ngā waea parauri i tēnei wā, a ka taea e 'diagonal cutting pliers' e ou ringa rānei te pōkai whakamuri, ā ka tākai i ngā herehere o te waea mā ngā raiti, nga paerongo, ngā pūkaha ōtira ētahi atu mea e hiahia ana te whakapiri ki te 'ROV'.

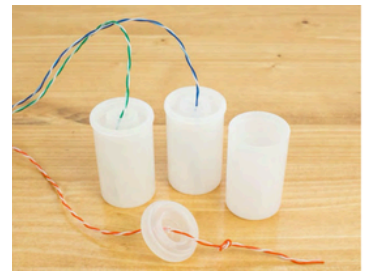

10. Kei te 'thruster housings' ngā taupoki, he ahua 6 inihi tetahi kara o ngā waea takirua, mai te kohao o te taupoki, mai o waho ki roto. Tāruatia tēnei hātepe ki ngā waea e rua e toi ana.



 **TĀKOHA** - Kei te pai ēnei whakapiri, heoi anō he pai ake ki te tākai i ngā whakapiri hiko, nō reira whakamahia ngā rautaki e rua.

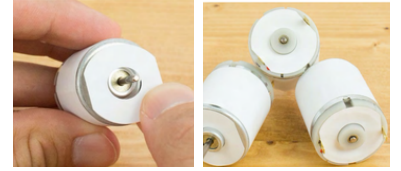

11. Kimihia te ira whero ki te wāhanga mā o ngā pūkaha hiko, he pā tata ki ngā kāpeke pūkaha. Ko te ira whero ka tohua te tōrunga (+) Mākahia te taunga o te (+) e pa tata ana ki te ira whero.
12. Kia mau tonu te whakapiri tūpuhi ki nga tahataha o te pūkaha kia ō ki te 'housing', pai kē atu te arai te pito whakarunga me te pito whakararo o te pūkaha. Kātahi ka whakapopo ngā pito whakarunga ā whakararo kia mau ki ngā tahataha, ā hei te mutunga āraitia ngā tahataha.
13. Whakamahia kia rima ngā wāhanga poto o ngā 1 inihi whakapiri ki ngā pito whakarunga ā whakararo, he rite ki te hātepe e whai ake nei. Ka whakaatu ngā whakaahua i te hātepe tauira whakapiri.
14. Ki te wahanga he nira te ahua, ā ka uhi te whakapiri o runga, pehi te whakapiri ki te nira kia kohaotia me te whakapiri.
15. Ko ngā whakapiri e rima e toe ana āraitia te katoa o te pūkaha, ka mutu tēnā, poroa ngā toenga whakapiri e.

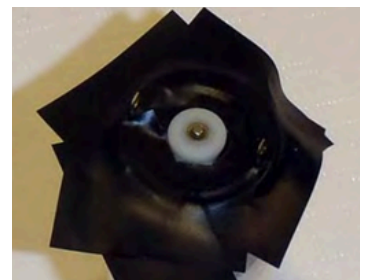

16. Tāruatia te hātepe whakapiri ki tērā atu taha o te pūkaha, otira, kia tika te kutikuti i te whakapiri ki ngā tahataha o te pūkaha kia ātaahua ngā tapa o te pūkaha.

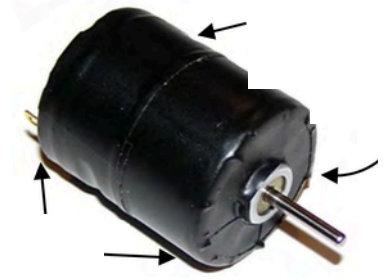

17. Kotuia te waea mā ngā pihi o te pūkaha, ko te waea tūmaro ka hono atu ki te pihi me te ira whero.

18. Takawiri te waea ki te waea āno kia kore ai e taka.

19. Tūhoto te waea ki te pihi.

WAIHANGA TE HURIRERE

 **TĀKOHA** - Kia tika rā te whakauru i te hurirere, kua mākahia ko te awawa e tapapa ana.

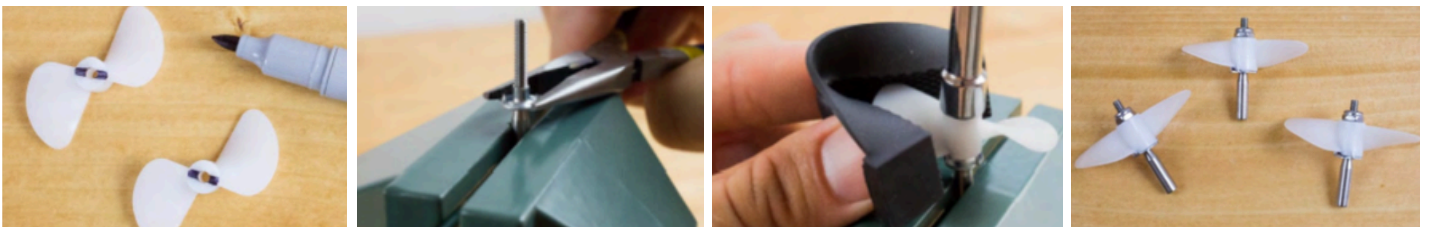

Kei te pukapuka tohutohu ngā whakaahua.

Nā www.seaperch.org i waihanga.

Nā Tōnui [Collab rāua ko Tapuwae Roa](#) i whakamāoritia.

KO TE ARAI WAI I NGĀ PŪKAHA

 **TĀKOHA** - Kia mataara, taihoa te kukume me te pana i ngā waea o te pūkaha. Kia ngāwari te mahi!

20. Kia iti noa te wākihi ka whakaurua e koe ki te ipu. Mirimiria te wākihi ki roto i te ipu, ko te tikanga ia, kia mau katoa ngā tahataha o te ipu me te wākihi.
21. Kia āta haere te whakauru atu te pūkaha ki roto i te ipu, ā kia puta mai te kakau i te ipu.
22. Whakakiiia te ipu me te wākihi, kātahi ka whakamau taupoki.
23. Ko te tikanga ia, kāore he hau takiwa ki roto i te ipu.
24. Mukua te katoa o te ipu me te patuero.

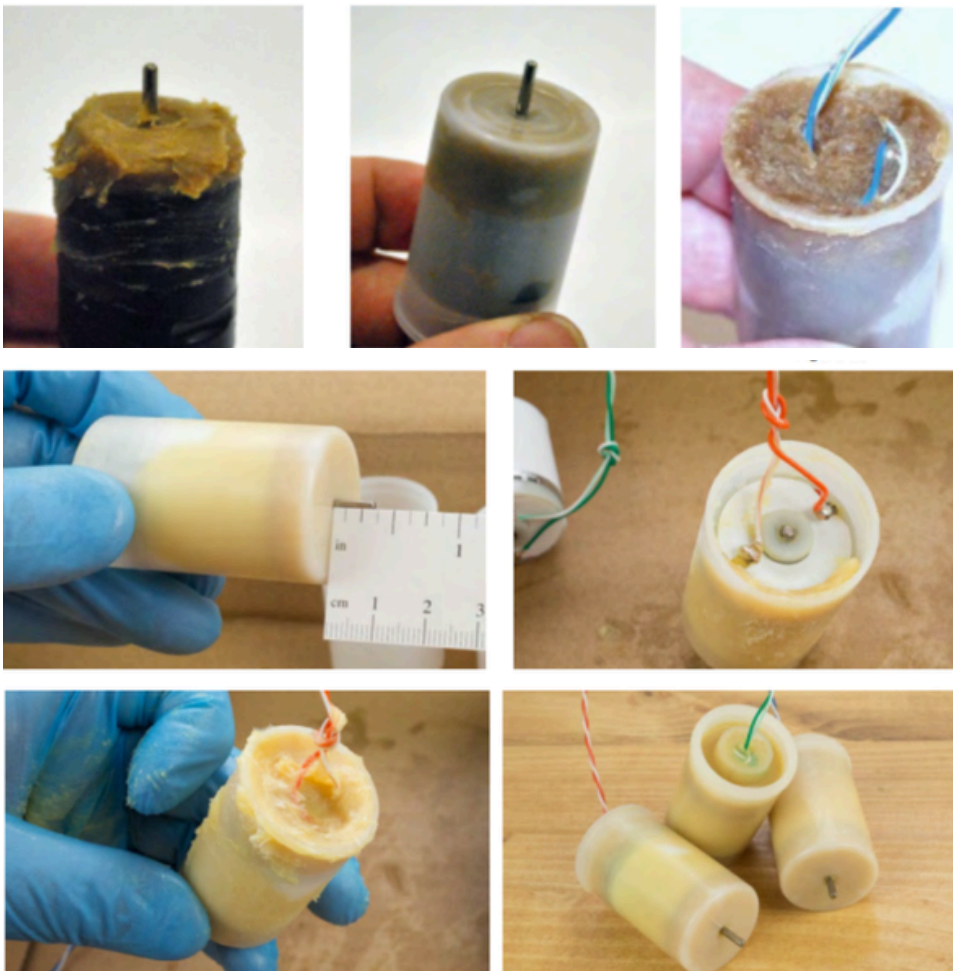

Kei te pukapuka tohutohu ngā whakaahua.

Nā www.seaperch.org i waihangā.

Nā Tōnui [Collab rāua ko Tapuwāe Roa](#) i whakamāoritia.

HURIRERE KI NGĀ PŪKAHA

25. Me mā ngā ringa i te wākihi.
26. Mukua te kakau o te pūkaha me te muku waiwaihā a muri mai i te hātepe arai wai, kia wātea te pūkaha i ngā toenga wākihi.
27. Whakamahia he pepa whakamaene kia mātoretore ai te kakau o te pūkaha, ā ka pai āno te hāpiapia.
28. Kia kaha ki te muku i te kakau me te pepa waiwaihā, kia tango i ngā toenga taoka nā te pepa whakamaene.
29. Kauga e pā i te kakau o te pūkaha, ko nga hinu o te ringa ka whakakore tika i te hāpiapia o te kāpia.
30. Tetepe he paku kāpia ki te pito whakararo o te kakau me tētahi tetepe o te kāpia ki te hahao whakararo o te 'shaft coupler'.
31. Panapanahia te hahao whakararo o te 'shaft coupler' ki te kakau o te pūkaha. waihoa he paku wharua (1/16) ki waenga i te 'shaft coupler' me te 'thrusting house'.
32. Whakamahia he aikiha, ā muka ngā toenga kāpia o te 'shaft coupler' me te kakau o te pūkaha.
33. Waiho te 'thruster' ki te taha mō te tekau mā rima mēneti kia maro te kāpia.
34. Ki te maro te kāpia, kōwiritia ngā pūkaha me ōu ringaringa kia wātea tēnei hangahanga hou.
35. Whakamahia āno nei ki ngā 'thrusters' e rua e toe ana.



ARAITIA TE WAI ME TE WAEA

11

36. Whakamiahia te 'Monkey Putty' kia hiri ai ngā waea e puta mai ana i te waea ethernet. Kātahi ka whakatēpa me te tēpa hīhiko kia kore ai e pā ki tētahi atu mea.
37. Āpiti atu he wāhanga paku o te 'Monkey Putty' ki te waea pito whakararo o te ipu, kia pai āno te ārai wai o te pūkaha.

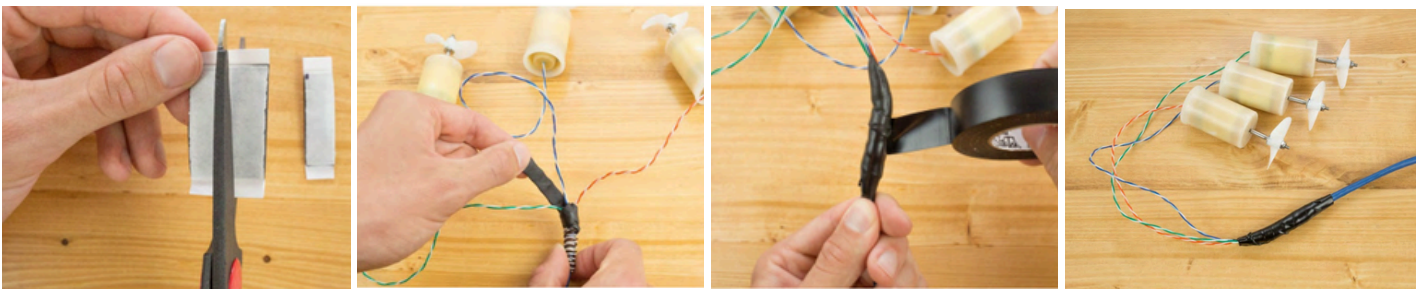

TE TUHONO O NGĀ 'MOTORS' KI TE 'ROV'

38. I mua te te āpiti atu o ngā pūkaha ki ngā taipari, WHAKAMĀTAUHIA!
Whakapiri i te raumamao ā aromatawai ngā pūkaha me nga tohutohu o RUNGA, o RARO, TE TAHA MATAU, TE TAHA MAUI hoki o ngā pūkaha.
39. Ā tirohia i te hononga o ngā taura, e rua o ngā taura, ko te taura tuarua ka raka, Rakaina te taura tuatahi ki huri rauna i te pūkaha.

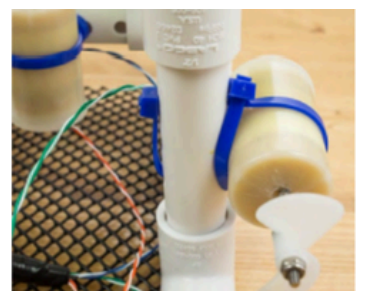

Kei te pukapuka tohutohu ngā whakaahua.

Nā www.seaperch.org i waihanga.

Nā Tōnui [Collab rāua ko Tapuwae Roa](#) i whakamāoritia.

O TE RAUMAMA

Me tauta ngā waehanga ā me tuhoto i te raupapa ā rahi tika mai i te mea iti noa i te tuatahi. Tirohia te i te tepu me te whakaahua i a koe e hangahanga ai.

Order	Component	PCB Location
1	Fuse Holder	F1
2	Toggle Switch	SW1
2	Toggle Switch	SW2
3	Pushbutton Switch	SW3
3	Pushbutton Switch	SW5
4	RJ45 Connector Jack	J1

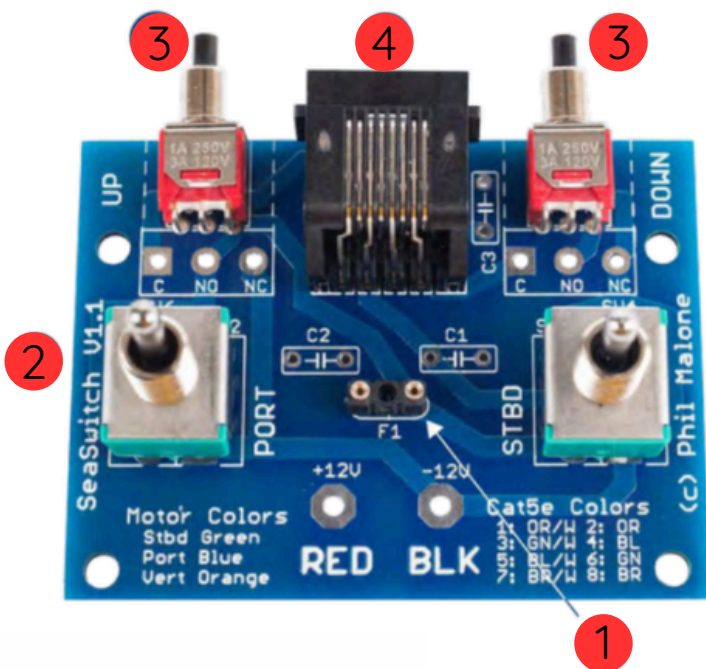

TĀKOHA

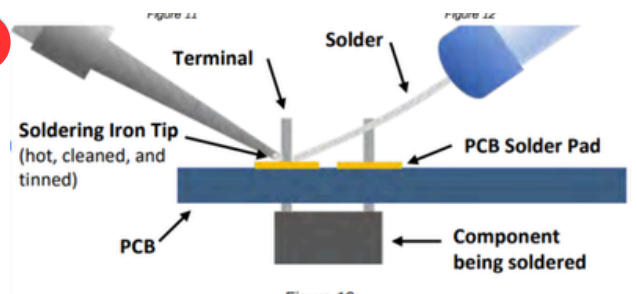

Kei te pukapuka tohutohu ngā whakaahua.

Nā www.seaperch.org i waihanga.

Nā Tōnui [Collab rāua ko Tapuwae Roa](#) i whakamāoritia.

KO TE WERO! he iti noa iho ēnei hononga ā e waru ngā wahanga, Kia tūpato rā ōtira kaua e hanga he periti i a koe tūhoto ai.

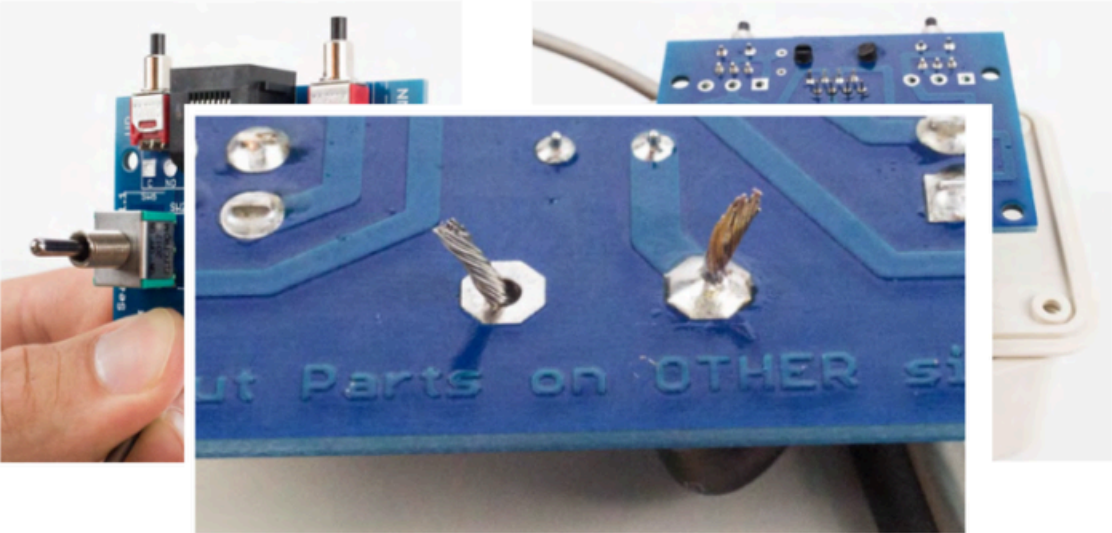
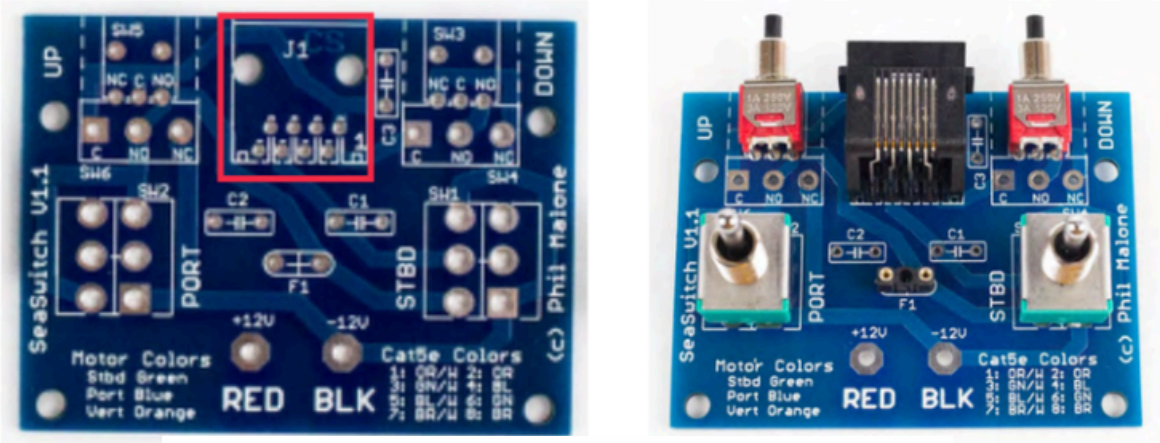

Figure 27

O TE WAEA HIKO

40. Wāwahi te waea ki ngā tōpito e rua kia 15cm.

41. Whakamahi ngā kuti wāwahi waea kia hura ai te waea konukura kia 2cm.

- Ka arai ko te waea konukura, ā ko tētahi o ngā waea kua arai me te whakapiri kōataata tē`ra atu waea ka kitea kua mākahia.
- Ko te mea kua mākahia ā ko te TŌRARO, ā ko te mea kōatata ko te TŌRUNGA.

42. Me whakamau te arai whero o te niho titi ki te waea TŌRUNGA.

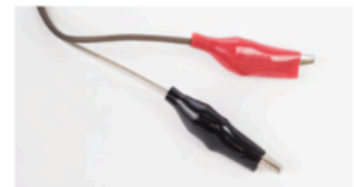

TE WHAKAURU I TE KATIARA

43. Kimihia te katiara.

44. Me tāuta e koe te katiara ki te pouaka katiara ki te 'PCB'.

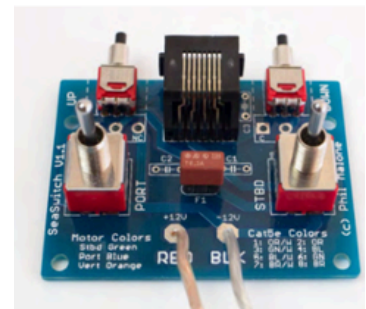

TE WHAKAOTI I TE RAUMAMA

 **TĀKOHA** - Haere tonu me tēnei wāhanga ki te tutuki i te whakamatau.

45. Tukua te 'PCB' ki te pouaka aratohu, ā ka tōhipa atu i te patene whakakā ā āta haere mā ngā kohao iti ki runga i te pouaka.
46. Whakamahia ngā tīwiri hiriwa paku e whā kia mau te 'PCB' ki te pouaka.
47. Me tāuta te taupoki ki runga i te pouaka aratohu whakapi, kātahi ka āta pokaitia ngā waea ki roto i te pouaka e koe a te wā e taupokina ai te pouaka.
48. Kia mau āno te taupoki me ngā tīwiri pango.
49. Pēhi atu ngā pātene pana poki whakawenwene e rua, ki ngā pana whakakā.

